

PSI-MOS-PROFIB/FO 660 T

Order No.: 2708287



<http://eshop.phoenixcontact.co.uk/phoenix/treeViewClick.do?UID=2708287>

FO converter with integrated optical diagnosis, alarm contact, for PROFIBUS up to 12 Mbps, T-coupler with two FO interfaces (FSMA), 660 nm, for polymer/HCS fiber cable



Commercial data

EAN	 4 017918 973988
Pack	1
Customs tariff	85176200
Gross weight in pieces	191.38 g
Country of Origin	DE
Catalog page information	Page 365 (CAT-8-2013)

Product notes

WEEE/RoHS-compliant since:
18/04/2007



Please note that the data given here has been taken from the online catalog. For comprehensive information and data, please refer to the user documentation at <http://www.download.phoenixcontact.com>. The General Terms and Conditions of Use apply to Internet downloads.

Technical data

Dimensions

Width	35 mm
Height	99 mm
Depth	106 mm

Serial interface

Interface 1	PROFIBUS acc. to IEC 61158, RS-485 2-wire, half duplex, automatic control
Operating mode	Semi-duplex
Connection method	D-SUB-9 female connector
File format/coding	UART (11 Bit, NRZ)
Data direction switching	Automatic control
Transmission medium	Copper
Transmission length	≤ 1200 m (depending on the data rate, with shielded, twisted pair data cable)
Conductor cross section solid min.	0.2 mm ²
Conductor cross section solid max.	2.5 mm ²
Conductor cross section stranded min.	0.2 mm ²
Conductor cross section stranded max.	2.5 mm ²
Conductor cross section AWG/kcmil min.	24
Conductor cross section AWG/kcmil max	14
Serial transmission speed	≤ 12 Mbps

Optical interface FO

Transmit capacity, minimum	-3 dBm (980/1000 μm)
	-15.4 dBm (200/230 μm)
Minimum receiver sensitivity	-30.00 dBm
Maximum receiver sensitivity	-3 dBm (980/1000 μm)
Wavelength	660 nm
Transmission length incl. 3 dB system reserve	70 m (With F-P 980/1000 230 dB/km with quick mounting connector)
	400 m (With F-K 200/230 10 dB/km with quick mounting connector)
Transmission medium	Polymer fiber
Transmission protocol	Protocol-transparent to the RS-485 interface
Connection method	F-SMA

Fault warning output

Maximum switching voltage	60 V DC
	42 V AC
Limiting continuous current	0.46 A

Power supply

Nominal supply voltage	24 V DC
Supply voltage range	18 V DC ... 30 V DC
Max. current consumption	130 mA
Typical current consumption	100 mA (24 V DC)
Connection method	COMBICON plug-in screw terminal block

General data

Bit delay	≤ 1 Bit
Bit distortion, input	± 35 % (permitted)
Bit distortion, output	< 6.25 %
Ambient temperature (operation)	-20 °C ... 60 °C
Ambient temperature (storage/transport)	-40 °C ... 85 °C
Permissible humidity (operation)	30 % ... 95 % (no condensation)
Altitude	5000 m (For restrictions see manufacturer's declaration)
Electrical isolation	(VCC // RS-485)
Test voltage data interface/power supply	1.5 kV _{rms} (50 Hz, 1 min.)
Electromagnetic compatibility	Conformance with EMC Directive 2004/108/EC
Noise emission	EN 55011
Noise immunity	EN 61000-6-2:2005
Degree of protection	IP20
Net weight	191 g
Housing material	PA 6.6-FR
Color	green
MTBF	201 Years (Telcordia standard, 25°C temperature, 21% operating cycle (5 days a week, 8 hours a day))
	42 Years (Telcordia standard, 40°C temperature, 34.25% operating cycle (5 days a week, 12 hours a day))
Conformance	CE-compliant
ATEX	Ex II 3 G Ex nAC IIC T4 X
	Ex II (2) GD [Ex op is] IIC (PTB 06 ATEX 2042 U)
UL, USA / Canada	Class I, Zone 2, AEx nc IIC T5
	Class I, zone 2, Ex nC nL IIC T5 X
	Class I, Div. 2, Groups A, B, C, D

Certificates



Certification cULus Recognized

Certification Ex: cULus Listed, ATEX

Certifications applied for:

Accessories

Item	Designation	Description
Cable/conductor		
2744652	PSM-CABLE-PROFIB/FC	PROFIBUS cable, Fast Connect type, up to 12 Mbps (02YSY (ST)CY 1x2x22 AWG)
2799885	PSM-LWL-HCS-RUGGED-200/230	HCS cable, duplex 200/230 µm, by the meter, without connector, for indoor installation
2799445	PSM-LWL-HCSO-200/230	HCS cable, duplex 200/230 µm, by the meter, without connector, for outdoor installation
2744319	PSM-LWL-KDHEAVY-980/1000	Polymer fiber cable, duplex 980/1000 µm, medium-weight version for permanent indoor installation, by the meter, without connector
2744322	PSM-LWL-RUGGED-980/1000	Polymer fiber cable, duplex, 980 µm/1000 µm, heavy version for permanent indoor installation, sold by the meter without connectors
2744982	PSM-LWL-RUGGED-FLEX	Polymer fiber cable, duplex 980/1000 µm, heavy-weight, highly flexible version for flexible conduit applications, by the meter, with connector
2744335	PSM-LWL-RUGGED-FLEX-980/1000	Polymer fiber cable, duplex 980/1000 µm, heavy-weight, highly flexible version for flexible conduit applications, by the meter, without connector
2744937	PSM-LWL/HCS-RUGGED	HCS cable, duplex 200/230 µm, by the meter, with connector, for indoor installation
2744940	PSM-LWL/HCSO	HCS cable, duplex 200/230 µm, by the meter, with connector, for outdoor installation
2744966	PSM-LWL/KDHEAVY	Polymer fiber cable, duplex 980/1000 µm, medium-weight version for permanent indoor installation, by the meter, with connector
2744979	PSM-LWL/RUGGED	Polymer fiber cable, duplex 980/1000 µm, heavy-weight version for permanent indoor installation, by the meter, with connector

General		
2709561	ME 17,5 TBUS 1,5/ 5-ST-3,81 GN	DIN rail connector for DIN rail power supply unit, gold-plated contacts, for DIN rail mounting, 5-pos.
2890014	ME 17,5 TBUS 1,5/PP000-3,81 BK	Plug component
2866983	MINI-SYS-PS-100-240AC/24DC/1.5	DIN rail power supply unit, primary-switched mode, slim design, output: 24 V DC / 1.5 A
2708863	PSI-REP-PROFIBUS/12MB	Modular repeater for electrical isolation and range increase for PROFIBUS up to 12 Mbps, 4-way isolation, rail-mountable, supply 24 V DC
2313944	PSI-TERMINATOR-PB	Active termination resistor with redundant voltage supply for PROFIBUS and RS-485 bus systems. Compact design. Electrical isolation between supply and data interface. Bus termination can be switched. Integrated programming interface.
2760623	PSM PTK	Passive RS-485 T-distributor, fitted with one 9-pin D-SUB pin strip and two 9-pin D-SUB socket strips
2799364	PSM PTK-4	Passive RS-485 T-distributor, fitted with one 9-pin D-SUB pin strip and five 9-pin D-SUB socket strips
2744429	PSM-ME-RS485/RS485-P	Repeater, for potential separation and range increase in RS-485 2-wire bus systems, 3-way isolation, rail-mountable
Plug/Adapter		
2799416	PSM-SET-FSMA-LINK/2	Coupling; set consisting of 2 couplings for connecting F-SMA plugs
2799487	PSM-SET-FSMA/4-HCS	F-SMA plug set for HCS fiber, for self assembly consisting of 4 quick mounting connectors with bend protection sleeve
2799720	PSM-SET-FSMA/4-KT	F-SMA plug set for polymer fiber, for self assembly consisting of 4 quick mounting connectors with bend protection sleeve
2313685	SUBCON-PLUS-PROFIB/90/PG/IDC	D-SUB connector, 9-pos., male connector, cable entry < 90°, bus system: PROFIBUS DP up to 12 Mbps with PG D-SUB socket for connecting a programming device, termination resistor can be switched on via slide switch, pin assignment: 3, 5, 6, 8; IDC terminal block connection
2313708	SUBCON-PLUS-PROFIB/90/PG/SC	D-SUB connector, 9-pos., male connector, cable entry < 90°, bus system: PROFIBUS DP up to 12 Mbps with PG D-SUB socket for connecting a programming device, termination resistor can be switched on via slide switch, pin assignment: 3, 5, 6, 8; screw connection terminal blocks
2744380	SUBCON-PLUS-PROFIB/AX/SC	D-SUB connector, 9-pos., male connector, axial version with two cable entries, bus system: PROFIBUS DP up to 12 Mbps, termination resistor can be switched on via slide switch, pin assignment: 3, 5, 6, 8; screw connection terminal blocks
2708245	SUBCON-PLUS-PROFIB/PG/SC2	D-SUB connector, 9-pos., male connector, cable entry < 35°, bus system: PROFIBUS DP up to 12 Mbps with PG D-SUB socket for connecting a programming device, termination resistor can be switched on via slide switch, pin assignment: 3, 5, 6, 8; screw connection terminal blocks

2708232	SUBCON-PLUS-PROFIB/SC2	D-SUB connector, 9-pos., male connector, cable entry < 35°, bus system: PROFIBUS DP up to 12 Mbps, termination resistor can be switched on via slide switch, pin assignment: 3, 5, 6, 8; screw connection terminal blocks
---------	------------------------	---

Tools

2799539	PSM-FO-POWERMETER	Fiber optic measuring case, consisting of an optical power meter, F-SMA, B-FOC adapters, reference fibers and operating instructions
2799526	PSM-HCS-KONFTOOL	HCS assembly kit for F-SMA quick mounting connectors, including stripping blade, stripping pliers, aramide yarn scissors, fiber stripper, microscope, fiber cleaving tool for standard HCS fibers, and documentation
2744131	PSM-POF-KONFTOOL	Polymer fiber DIY case, consisting of: Stripping knife, stripping pliers, polishing wheels for F-SMA and SCRJ quick mounting connectors, polishing pad and emery paper
2799348	PSM-SET-FSMA-POLISH	Polymer fiber polishing set, for F-SMA quick mounting connectors
2744623	PSM-STRIP-FC/PROFIB	Quick stripping tool for PROFIBUS cable, type Fast Connect
1205037	SZS 0,4X2,5 VDE	Screwdriver, slot-headed, VDE insulated, size: 0.4 x 2.5 x 80 mm, 2-component grip, with non-slip grip

Drawings

Application drawing

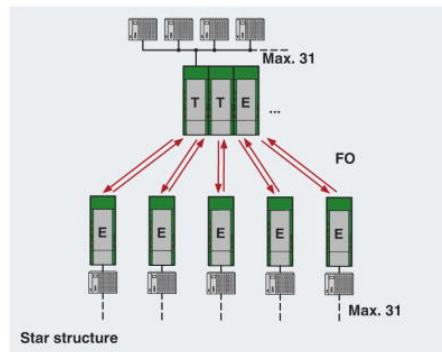
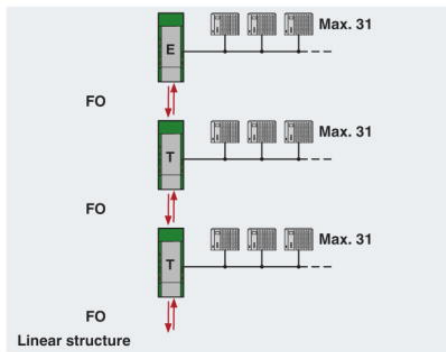

Tree structure

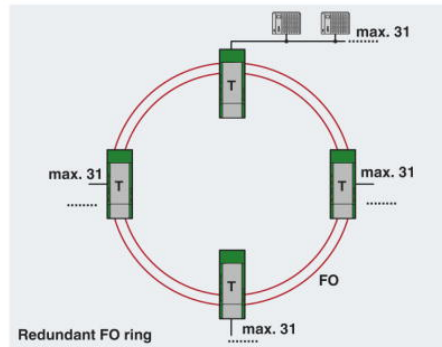
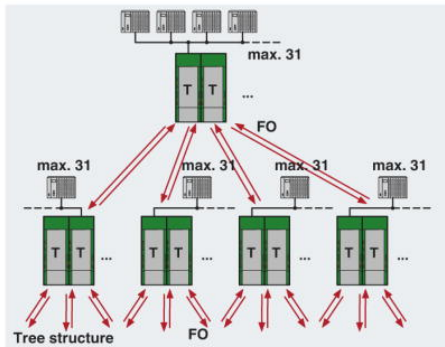

Redundant FO ring

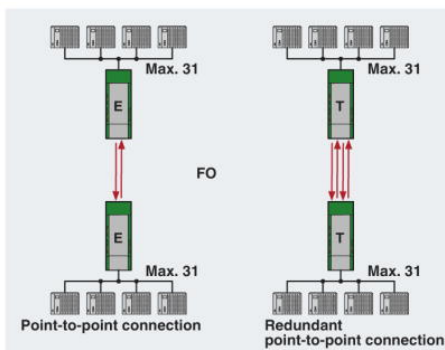

Block diagram

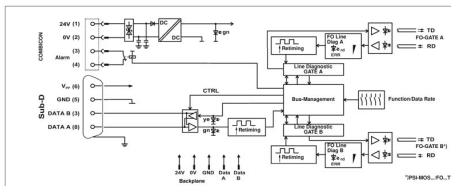

*) only with PSI-MOS.../FO...T

Address

PHOENIX CONTACT Ltd
Halesfield 13
Telford / Shropshire / TF7 4PG,England
Phone 01952 681 700
Fax 01952 681 799
<http://www.phoenixcontact.co.uk>



Phoenix Contact Ltd.
Technical modifications reserved;